

Ponndorf

PD & PD/2 Series Pumps

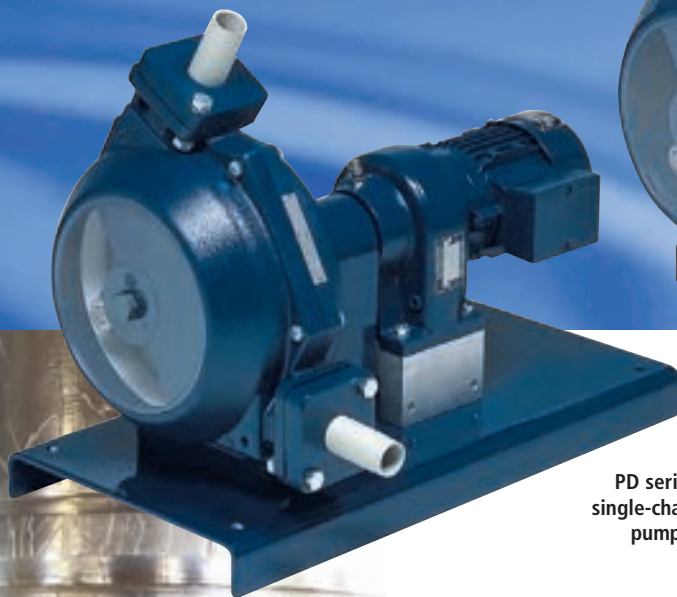

PD series single-channel pump



PD/2 series dual-channel pump



- Metering, transfer, and high-pressure filtration
- Self-priming and low-pulsation models
- Flow capacities are available up to 5.5 m³/hr (24 GPM) for single hose and up to 9.5 m³/hr (42 GPM) with our unique dual hose design
- Pressure up to 4 bar (60 psig)
- Dry running design provides long tubing life and prevents system contamination should the hose ever rupture
- Easy hose replacement without disassembly of the pump
- Flanged tube bed prevents side-to-side movement of the hose
- Pumps are shipped complete with motor and fixed-speed drive systems ready to install and start
- Optional drives include mechanical variable speed, variable-frequency, hazardous-area rate, washdown, chemical duty, air-operated, or base shaft pump only
- Dual hose models available (PD/2)



Catalog number	PD 15	PD 15/2	PD 27	PD 27/2	PD 35	PD 35/2
Normal capacity 165 rpm m ³ /hr (GPM)	0.5 (2.2)	0.95 (4.2)	2.5 (11)	4.8 (21.1)	5.5 (24.2)	9.5 (41.8)
Normal capacity 100 rpm m ³ /hr (GPM)	0.3 (1.3)	0.55 (2.6)	1.6 (6.6)	2.9 (12.8)	3.3 (14.5)	5.8 (25.4)
Hose ID, mm (in.)	15 (0.59)	15 (0.59)	27 (1.06)	29 (1.06)	51 (2.01)	35 (1.38)
Connection OD, mm (in.)	25 (0.98)	25 (0.98)	33 (1.30)	33 (1.30)	33 (1.30)	51 (2.01)
Max power, hp (kW)	½ (0.37)	¾ (0.55)	¾ (0.55)	2 (1.1)	2 (1.1)	5 (3)
Dimensions (L x W x H), mm (in.)	600 x 300 x 225 (23.62 x 11.81 x 8.84)		600 x 300 x 314 (23.62 x 11.81 x 12.36)		600 x 300 x 434 (23.62 x 11.81 x 17.09)	
Est. wt with motor kg (lb)	38 (84)	49 (107)	49 (107)	69 (152)	92 (202)	139 (306)
Construction materials						
Housing	Cast aluminum					
Tube bed	PTFE					
Inlet/outlet fittings	Polypropylene or 316 SS					
Rollers	Carbon-filled PTFE					
Rotor	Cast aluminum					
Shaft	Stainless steel					
Bearings	Permanently sealed grease filled ball bearings					
Hose material options	Natural rubber					
Max rpm	165					
Max temperature (continuous)	60°C (140°F)					
Max temperature intermittent	80°C (176°F)					
Max pressure	4 bar (60 psig)					
Max suction height	8 m (26 ft)					
Max viscosity	35,000 cPs (160,000 ssu)					

Optional inlet and outlet connections available include ANSI 150# flanges, Sanitary Tri-Clamp® fittings, and NPT connections.

Note: Connectors and hose must be ordered separately.

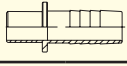
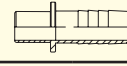
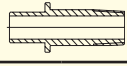
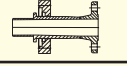
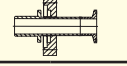
Pump series										
	Polypropylene		Stainless steel		Stainless steel		Stainless steel		Stainless steel	
	Hose ID (mm)	Cat. no.	Hose ID (mm)	Cat. no.	NPT	Cat. no.	Flange size	Cat. no.	Tri-Clamp size	Cat. no.
PD 15 or PD 15/2	25.2	VA-61114	25.2	VA-61115	½"	VA-61116	½"	VA-61522	½"	VA-61523
PD 27 or PD 27/2	33.0	VA-61214	33.0	VA-61215	1"	VA-61216	1"	VA-61621	1"	VA-61622
PD 35 or PD 35/2	51.0	VA-62010	51.0	VA-61711	1½"	VA-61713	1½"	VA-61714	1½"	VA-61721

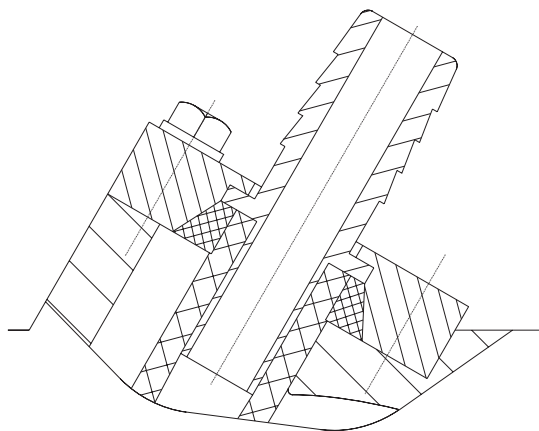

Discharge

Compression ring
secures hose against
inlet/discharge connector,
providing a leak-proof
connection

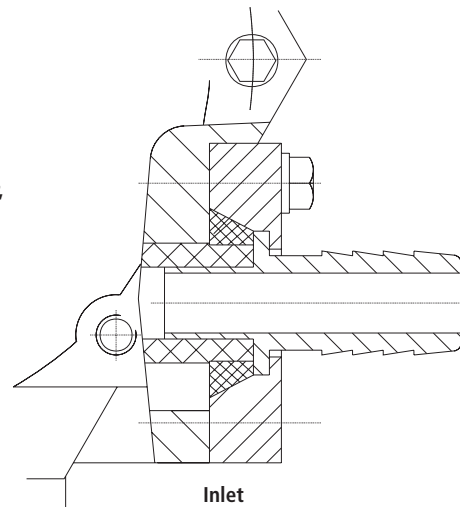

Inlet