

NOTES:

1. TANK IS MANUFACTURED TO ASTM-D-1998 STANDARD.
2. ALL DIMENSIONS ARE APPROXIMATE.

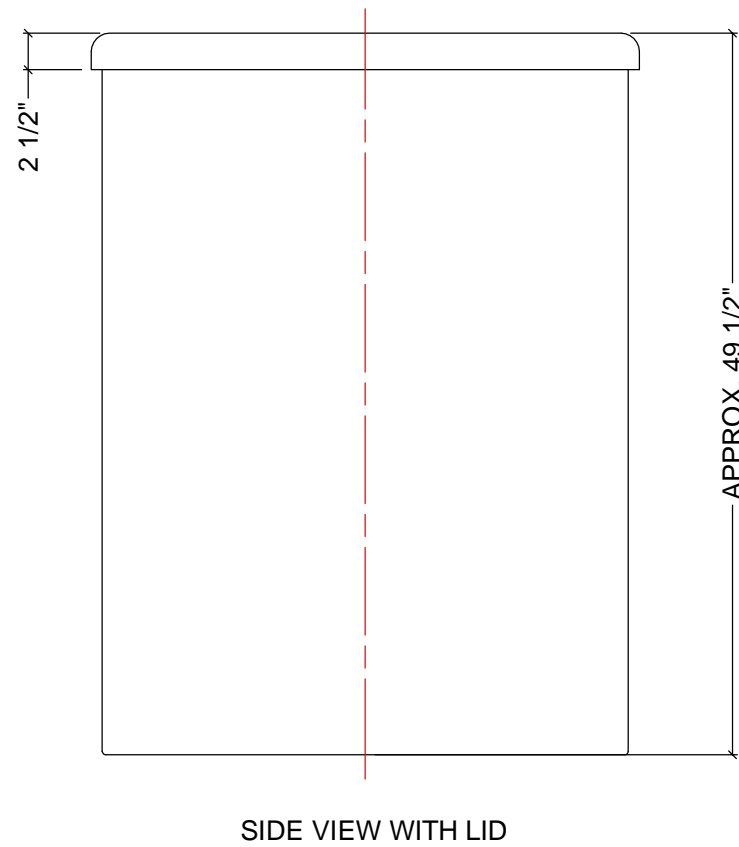

MATERIALS LIST		
ITEMS	DESCRIPTION	NOTES
A	OT-175 OPEN TOP TANK	
B	LID FOR OT-175	

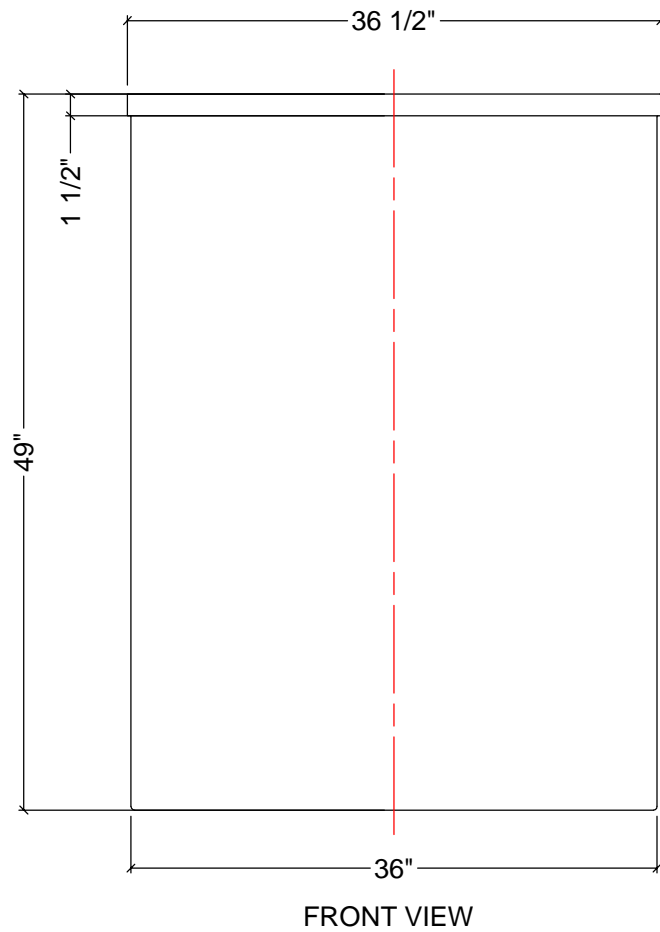
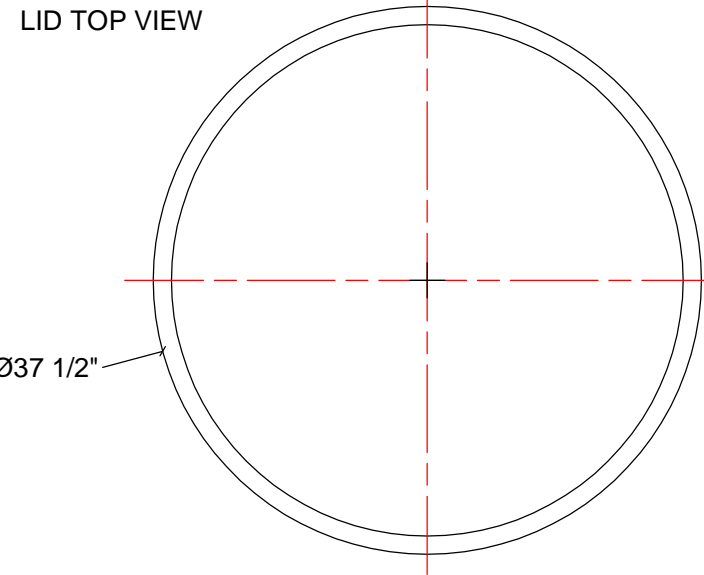
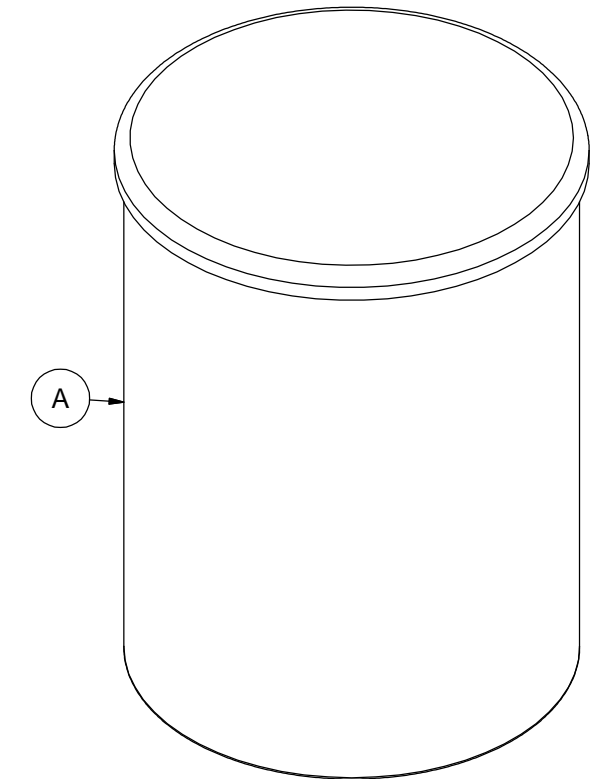

REV	DATE	DESCRIPTION	BY	APPD	REVD	
REVISIONS						
CUSTOMER						
TITLE		ACO JOB NO:				
175 I.G. OPEN TOP TANK WITH LID		PURCHASE ORDER NO:				
		PURCHASER'S EQUIP. NO:				
THIS DRAWING IS THE PROPERTY OF ACO CONTAINER SYSTEMS LTD. AND SHALL NOT BE COPIED OR TRANSFERRED WITHOUT THE WRITTEN CONSENT OF ACO CONTAINER SYSTEMS LTD.						
ENGINEERS SEAL		ACO CONTAINER SYSTEMS LTD.				
		<small>PICKERING - ONTARIO - CANADA</small>				
		ACO CONTAINER SYSTEMS LTD.		DESIGNED		
		794 MCKAY RD.		DRAWN	WM	
		PICKERING, ONTARIO, CANADA		CHECKED		
		L1W 2Y4		APPROVED		
		TEL. 905-683-8222		SCALE	N.T.S.	
		FAX 905-683-2969		DATE	27-05-09	
DWG No		OT-175-L			REV	0