

NOTES:

1. TANK IS MANUFACTURED TO ASTM-D-1998 STANDARD.
2. ALL DIMENSIONS ARE APPROXIMATE.

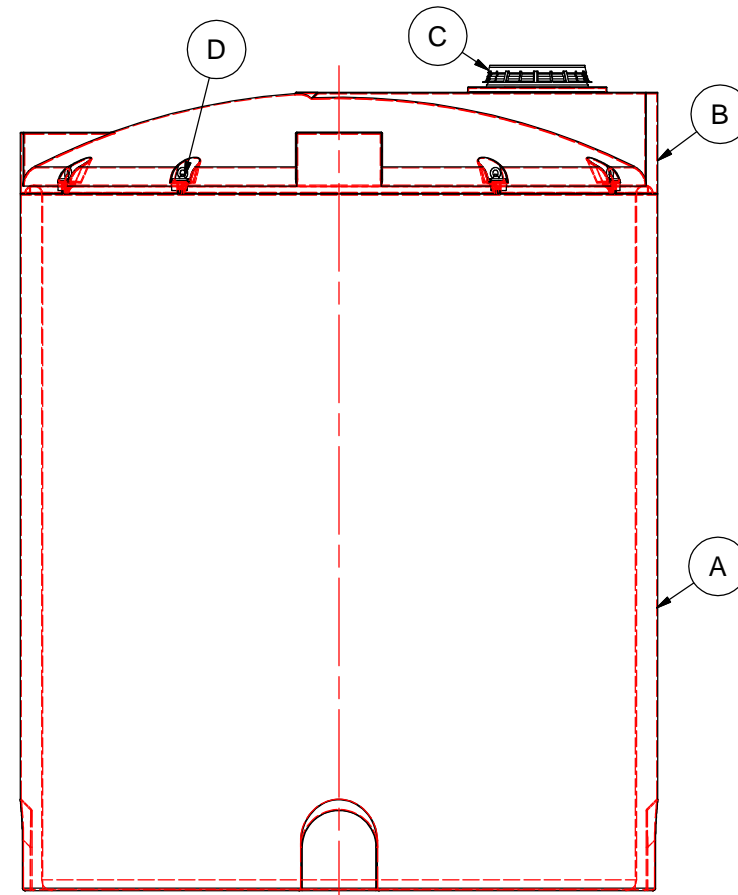

MATERIALS LIST		
ITEMS	DESCRIPTION	NOTES
A	DMT-4300-OUTSIDE	
B	DMT-4300-INSIDE	
C	16" LID WITH LOCKING STRAP (OPTIONAL 21" TREADED LID)	
D	DMT LIFTING LUG ASSEMBLY	8 PLACES

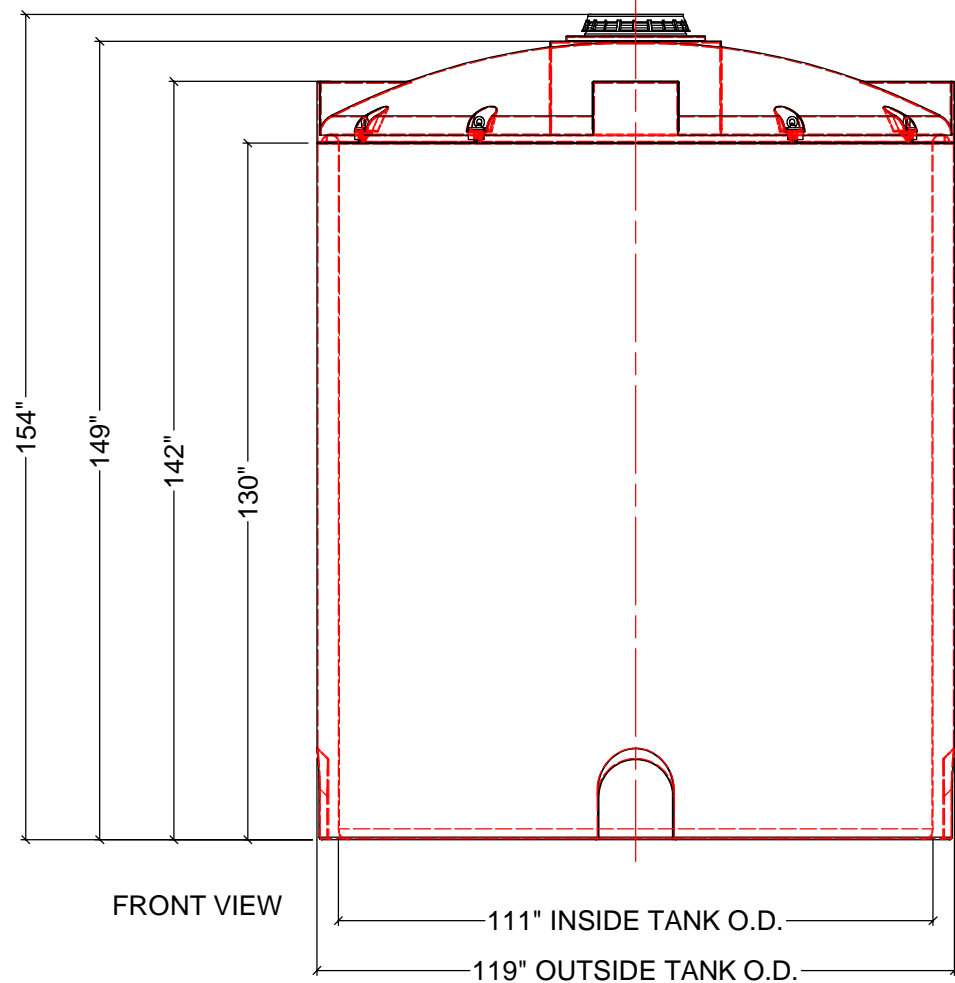
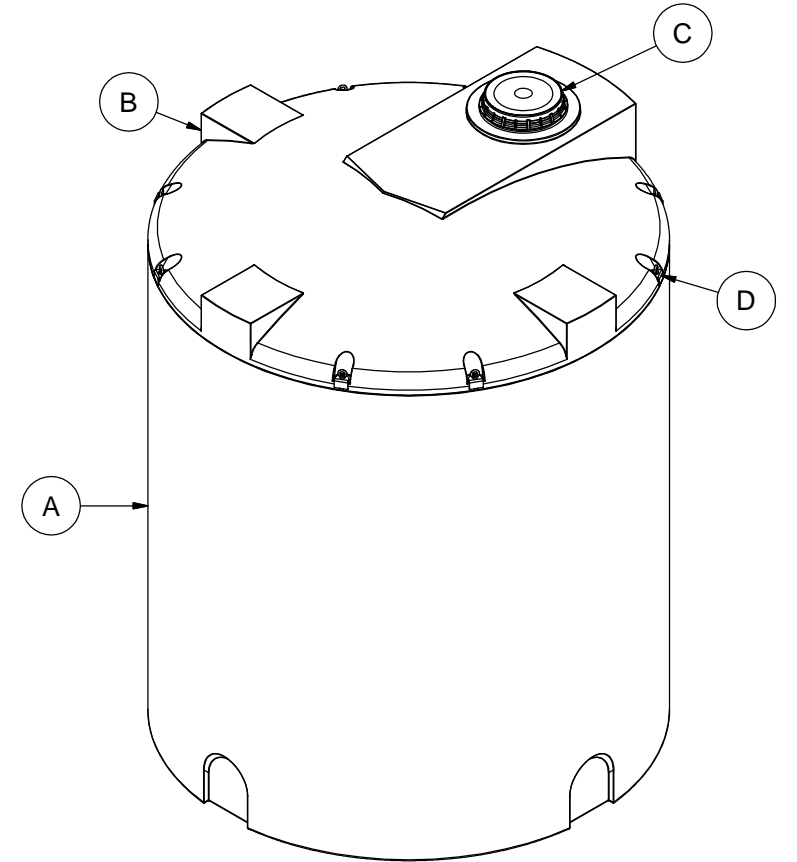

REV	DATE	DESCRIPTION	BY	APPD	REVD
REVISIONS					
CUSTOMER					
TITLE 4300 I.G. DOUBLE WALL TANK			ACO JOB NO: PURCHASE ORDER NO: PURCHASER'S EQUIP. NO:		
THIS DRAWING IS THE PROPERTY OF ACO CONTAINER SYSTEMS LTD. AND SHALL NOT BE COPIED OR TRANSFERRED WITHOUT THE WRITTEN CONSENT OF ACO CONTAINER SYSTEMS LTD.					
ENGINEERS SEAL		ACO CONTAINER SYSTEMS LTD.			
		PICKERING - ONTARIO - CANADA ACO CONTAINER SYSTEMS LTD. 794 MCKAY RD. PICKERING, ONTARIO, CANADA L1W 2Y4 TEL. 905-683-8222 FAX 905-683-2969		DESIGNED	WM
				DRAWN	
				CHECKED	
				APPROVED	
				SCALE	N.T.S.
				DATE	20-05-09
DWG No		DMT-4300			REV 0