

NOTES:
 1. TANK IS MANUFACTURED TO ASTM-D-1998 STANDARD.
 2. ALL DIMENSIONS ARE APPROXIMATE.

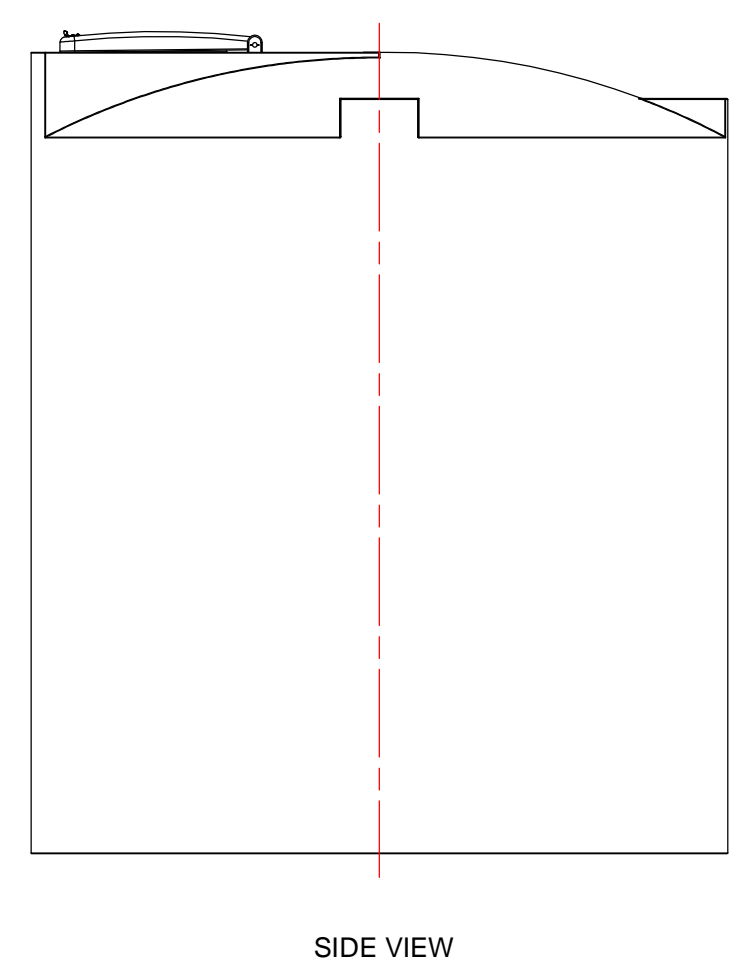

MATERIALS LIST		
ITEMS	DESCRIPTION	NOTES
A	CT-8000 TANK	
B	24" HDPE HINGED MAN WAY	

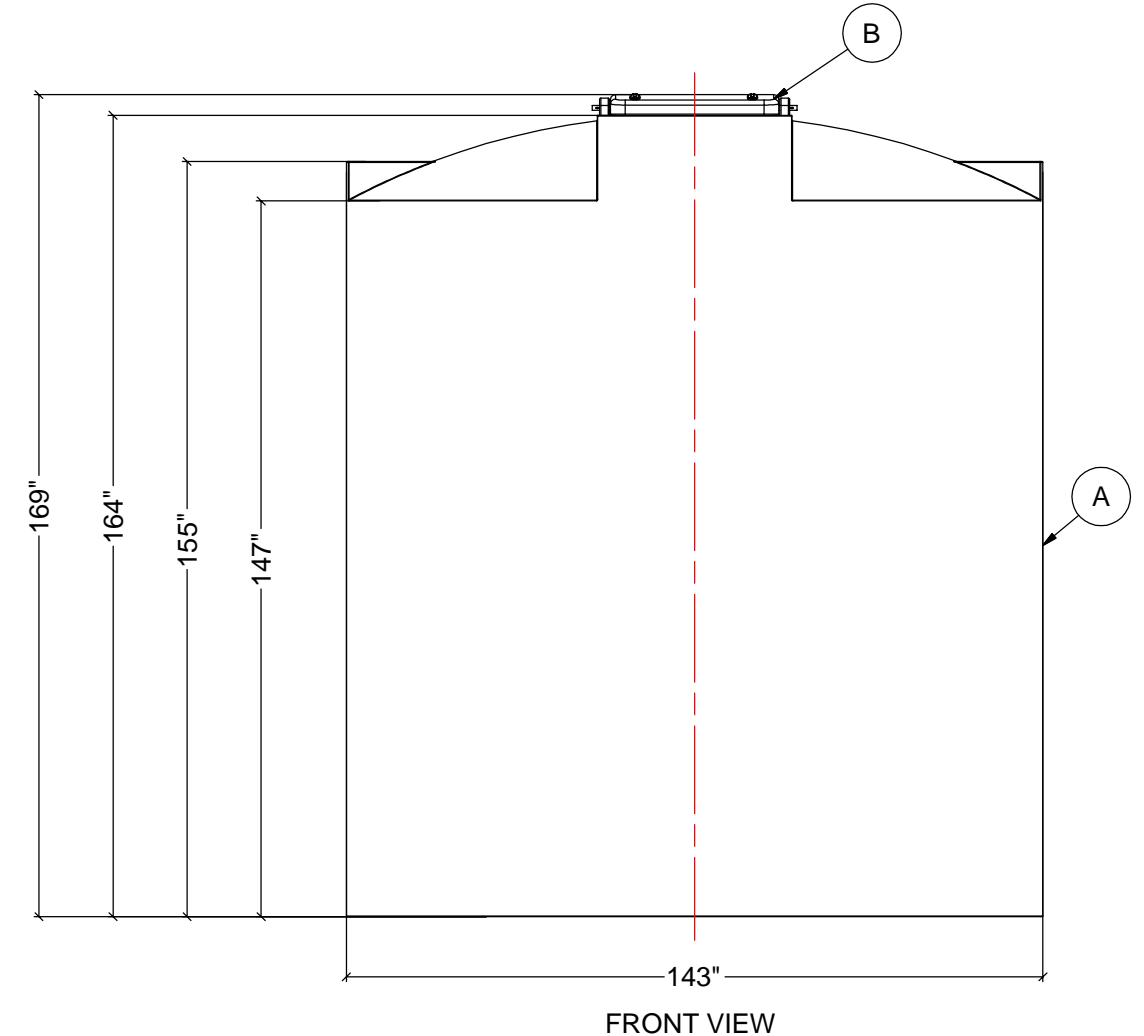
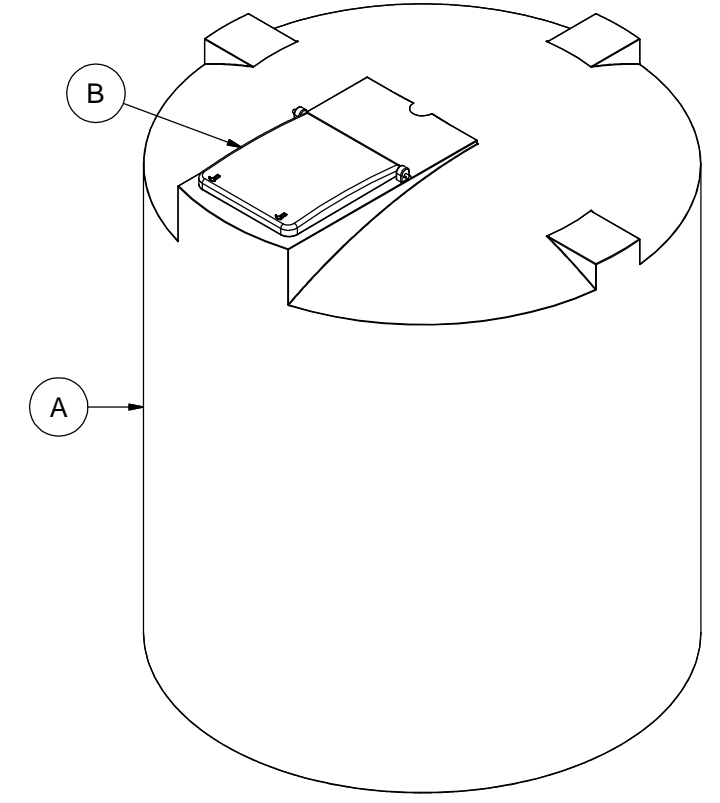

REV	DATE	DESCRIPTION	BY	APPD	REVD
REVISIONS					
CUSTOMER					
TITLE 8000 I.G. CLOSED TOP TANK			ACO JOB NO: PURCHASE ORDER NO: PURCHASER'S EQUIP. NO:		
THIS DRAWING IS THE PROPERTY OF ACO CONTAINER SYSTEMS LTD. AND SHALL NOT BE COPIED OR TRANSFERRED WITHOUT THE WRITTEN CONSENT OF ACO CONTAINER SYSTEMS LTD.					
ENGINEERS SEAL		ACO CONTAINER SYSTEMS LTD.			
PICKERING - ONTARIO - CANADA ACO CONTAINER SYSTEMS LTD. 794 MCKAY RD. PICKERING, ONTARIO, CANADA L1W 2Y4 TEL. 905-683-8222 FAX 905-683-2969		DESIGNED			
		DRAWN			WM
		CHECKED			
		APPROVED			
		SCALE			N.T.S.
		DATE			14-05-09
DWG No		CT-8000			REV 0